

REV	REVISION	BY	ECN	DATE

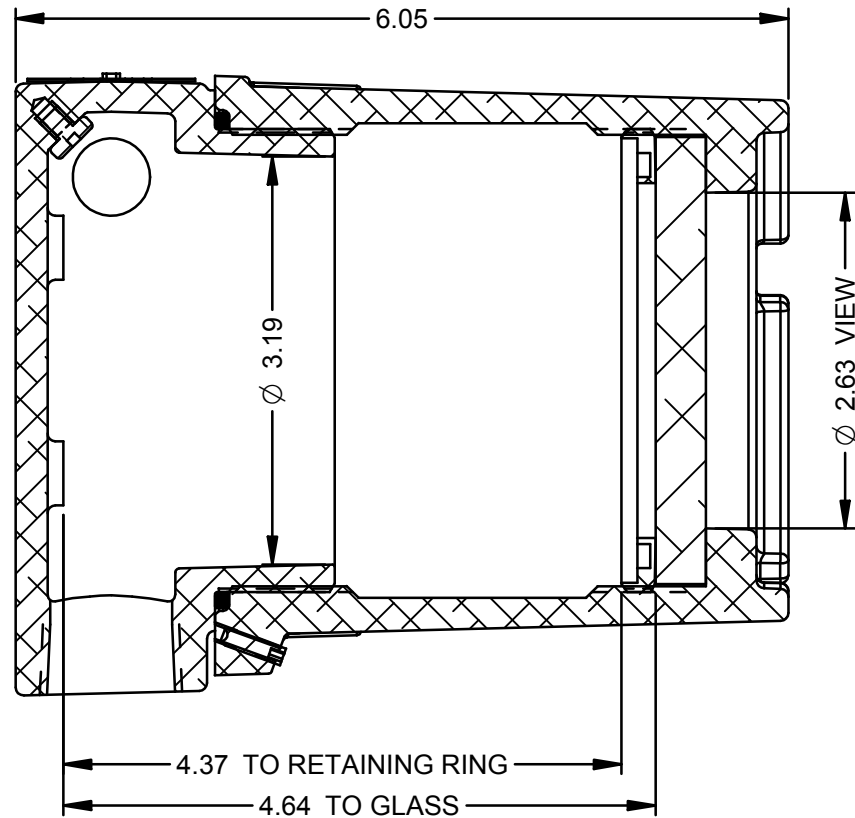

SECTION A-A
1:1.5

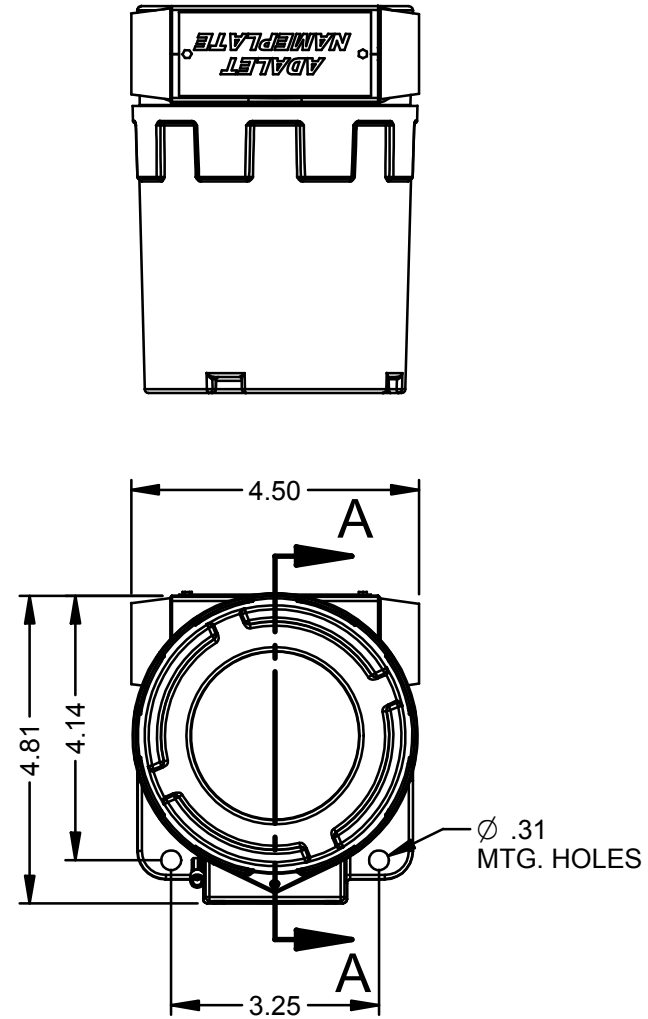

FOUR (4) INTERIOR MOUNTING BOSSES
(CAN ACCOMMODATE BLIND TAPPED
HOLES ON A Ø2-1/2" BOLT CIRCLE)

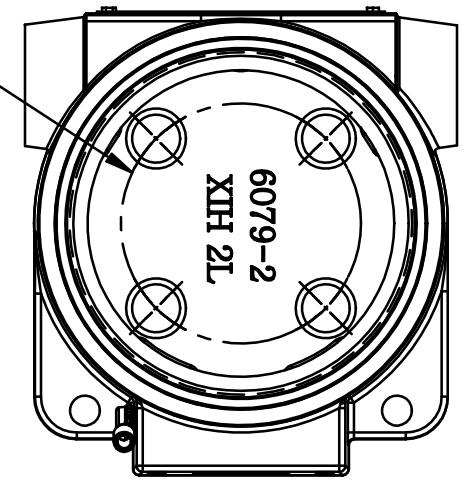

COVER REMOVED
1:2

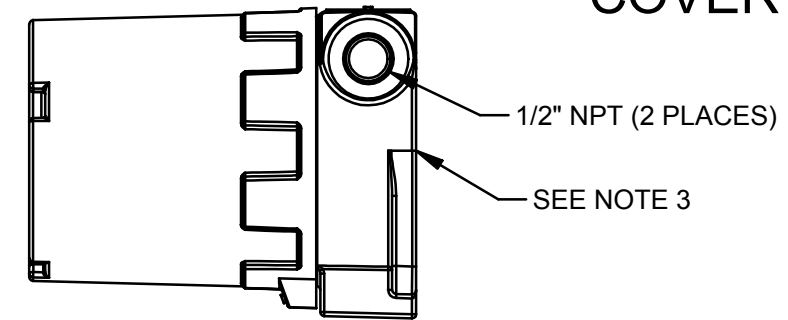

NOTES:

- STANDARD APPROVALS: UL/cUL CLASS I, DIVISION 1, GROUP B; NEMA TYPES 4X/7/9. ATEX APPROVAL OPTIONAL - - CONSULT FACTORY
- STANDARD FINISH: SAFETY BLUE POLYESTER POWDERCOAT. OTHER COLORS AVAILABLE.
- OPTIONAL BACKWALL ENTRY AVAILABLE. (SEE "ENTRY OPTIONS" LIST FOR SIZES) - - CONSULT FACTORY
- OPTIONAL FRONT BOSS ENTRY AVAILABLE. (SEE "ENTRY OPTIONS" LIST FOR SIZES)
- FOUR (4) OPTIONAL 1/4-20 HOLES IN FRONT BOSS FOR BRACKET MOUNTING - - CONSULT FACTORY
- CONSULT FACTORY FOR ADDITIONAL CUSTOM MACHINING

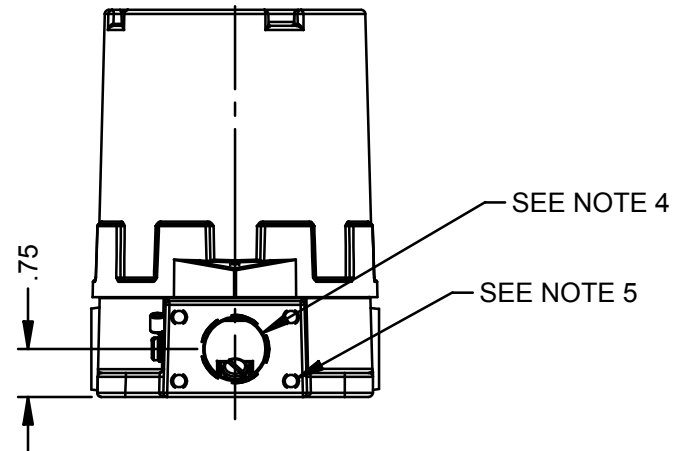

DIMENSIONS SHOWN ARE FOR REFERENCE ONLY, NOT FOR MANUFACTURING. CONTACT ADALET ENGINEERING FOR TIGHT FITS OR TOLERANCE ISSUES!

**DO NOT REVISE THIS DWG. IN AUTOCAD
3D GENERATED IN SOLID EDGE**

ENTRY OPTIONS:

- 1/2" NPT
- 1/2" NPSM
- 3/4" NPT
- 3/4" NPSM
- 20mm x 1.5
- 25mm x 1.5

DO NOT SCALE DRAWING UNLESS OTHERWISE SPECIFIED DIMENSIONS ARE IN INCHES.	MACHINE TOLERANCES ON DIMENSIONS NOT OTHERWISE SPECIFIED: √ 125 .XX ± .03" .XXX ± .010" Fillet RADII .03" EDGE BREAK .005"-.015" R. or 45° ANGLES ± 0°-30°
CAST TOLERANCES ON DIMENSIONS NOT OTHERWISE SPECIFIED: √ = 1/8" STOCK MIN FILLET OR CORNER RADII 1/8" DRAFT 1 1/2° FRAC ± 1/16" ANGLES ± 1°	GAGING FOR THREADED HOLES NOT OTHERWISE SPECIFIED: NPT E-21-2.6 NPSM E-24-1.0



NOTICE TO PERSONS RECEIVING THIS DRAWING:
ADALET CLAIMS PROPRIETARY RIGHTS IN THE MATERIAL DISCLOSED HEREON. THIS DRAWING IS ISSUED IN CONFIDENCE FOR ENGINEERING INFORMATION ONLY AND MAY NOT BE REPRODUCED OR USED TO MANUFACTURE ANYTHING SHOWN HEREON WITHOUT DIRECT WRITTEN PERMISSION FROM ADALET TO THE USER.

TITLE XIHDGCX 2L OUTLINE DRAWING		DRAWN BY MCP	DATE 01/07/09
MATERIAL E-STD-E4		ENG APPROVAL	PLOT SCALE 1=3
FINISH TUMBLAST		MFG APPROVAL	DWG SIZE B
CAT NO	DWG NO XIHDGCX 2L	SHT 10F1	REV A