

Increased Safety Enclosures

INCREASED SAFETY ENCLOSURES

Adalet offers a variety of enclosures which are rated to the increased safety (Exe) method of protection. These enclosures provide an alternative to flameproof enclosures and are intended to house electrical components which will not generate an arc or spark during normal operation. Additional design measures are taken to prevent the possibility of excessive heat, the ingress of water or dust, and the resistance to impact, thus preventing any explosions from occurring. From simple terminal enclosures to high voltage and control enclosures, Adalet's line of increased safety enclosures offers the flexibility to meet your custom requirements.

PRINCIPLE

Intended for product in which arcs and sparks do not occur in normal service or under fault conditions and in which surface temperatures are controlled below incendive values. Increased Safety is achieved by enhancing insulation values and creepage and clearance distances above those required for normal service, thus providing a safety factor against accidental breakdown.

Increased Safety must not be confused with Intrinsically Safe; they are two completely different approaches.

Intrinsic Safety requires that the electrical components within an enclosure have very low levels of electrical energy, either stored or circulating. Typically, allowable currents will be in the tens of milliamperes and voltage will be less than 100 volts, so they will be insufficient to ignite a surrounding explosive atmosphere even under fault conditions.

KEY DESIGN FEATURES

- **Enclosure:** must be constructed to withstand mechanical impact and provide a specified degree of ingress protection (IP rating). A minimum IP54 rating is required for Increased Safety enclosures.
- **Terminals for external connections:** must be generously dimensioned for the intended connection and ensure that conductors are securely fastened.
- **Internal connections:** must not be subject to undue mechanical stress and shall be made using specified methods.
- **Clearances:** between bare conductive parts must not be less than the values specified according to the rated voltage.
- **Creepage distances:** must not be less than the values specified according to the rated voltage and the Comparative Tracking Index (CTI) of the insulating material.
- **Temperatures:** of parts of equipment must be limited so as not to exceed values which would affect the thermal stability of the material and the T-Class relating to the ignition of explosive atmospheres.

Designed to protect in areas where flammable gases, vapors, liquids and dusts can exist.

Increased Safety Enclosures



Contents

Increased Safety Enclosures

Quarter Turn Latch Terminal Enclosures	6
VH4X Series	8
VC4X Series	10
Screw Cover Terminal Enclosures (TSC Series)	14
Clamped Door Terminal Enclosures (TN Series)	34
Control Enclosures (CN Series)	76
Increased Safety Controls	82
Pushbutton Station Enclosures	85
High Voltage Junction Boxes (HV Series)	87
Principles, Markings & Design Guidelines	90

Quarter Turn Latch Terminal Enclosures

The VC4X6 & VH4X6 increased safety enclosures are cULus, ATEX, GOST, and IECEx certified to house terminal block assemblies in Exe rated Zone 1 & 2 hazardous locations. The completed enclosure line includes 13 standard VH sizes and 24 VC standard sizes. Adalet also offers the option for custom sizes to meet most specifications.

The enclosures feature a continuous one piece silicone gasket which provides an IP66 ingress rating for dust-tight and water-tight locations. Standard lift-off door hinges are included for easy removal of the cover. The quarter turn door latches are designed with security in mind and include a double bit insert. Mounting feet can be oriented in either horizontal or vertical directions and an internal / external earth stud is included as standard. The enclosures are equipped with a painted steel mounting panel for mounting DIN rail and terminal block assemblies.

STANDARD FEATURES

- 37 standard sizes available
- Stainless steel quarter turn latch with 3mm double bit insert (includes key)
- Continuous one-piece water tight silicone gasket
- Lift off door hinges
- Painted steel mounting panel
- Ground stud on box and cover
- External earth stud
- Wall mounting feet (vertical or horizontal)

DESIGN FEATURES

- Gland plates (6" deep or greater) can be supplied pre-drilled or blank for field drilling
- Drilled entries and cut-outs
- Breather / drain
- Stopping plugs
- Terminal block assemblies
- Stainless steel mounting panels
- Cable glands and conduit fittings
- Internal earth bar
- Custom sizes



MATERIAL

- Type 304 or 316L Stainless Steel
- Enclosure and cover constructed from 14 gauge (.075) stainless steel with #3/4 brush finish
- Gland plates constructed from 12 gauge (.1054) stainless steel with a #3/4 brush finish
- Silicone gasket constructed from 1/4" Bisco silicone with acrylic PSA
- Gland plate gasket constructed from 1/8" Bisco silicone with acrylic PSA

VH4X Series

Mounting feet on left and right of enclosure.

MATERIAL

- Enclosure & cover constructed of 14 ga. (.075) 316L stainless steel with #3/4 brush finish
- Optional gland plate constructed of 12 ga. (.1054) 316L stainless steel with #3/4 brush finish
- Cover gasket: ¼" thick Bisco silicone with acrylic PSA, Part #HT805A
- Gland plate gasket: ⅛" thick Bisco silicone with acrylic PSA, Part #HT805A

OPTIONS

- Optional pressure sensitive adhesive gasket material, Part #HT8055
- Optional Quarter Turn Inserts:
 - Slot
 - 8MM Hex Socket
 - 7MM Triangle
 - 8MM Triangle
 - 7MM Square
 - 8MM Square
 - 5mm Double Bit
 - Bellcore 216
 - Railway standard

VC4X Series

Mounting feet can be on left and right OR top and bottom of enclosure.

MATERIAL

- Enclosure & cover constructed of 14 ga. (.075) 316L stainless steel with #3/4 brush finish
- Optional gland plate constructed of 12 ga. (.1046) 316L stainless steel with #3/4 brush finish
- Cover gasket : ¼" thick Bisco silicone with acrylic PSA, Part #HT805A
- Gland plate gasket : ⅛" thick Bisco silicone with acrylic PSA, Part #HT805A

OPTIONS

- Optional pressure sensitive adhesive gasket material, Part #HT8055
- Optional Quarter Turn Inserts:
 - Slot
 - 8MM Hex Socket
 - 7MM Triangle
 - 8MM Triangle
 - 7MM Square
 - 8MM Square
 - 5mm Double Bit
 - Bellcore 216
 - Railway standard

CERTIFICATIONS

POPULATED ENCLOSURE

Class I, Division 2, Groups A, B, C, D
 Class II, Division 2, Groups F, G
 Class I, Zone 1, AEx e II T6 (T5 Tamb +55 °C)
 Ex e II T6 (T5 Tamb +55 °C)
 NEMA Type 4X, 12, 13
 CE 0539 II 2 GD
 IECEx UL 08.0012X
 IECEx Ex e II T6 (T5 Tamb +55 °C)
 IECEx Ex tD A21 IP66 T200 °C
 Ex e II T6 (T5 Tamb +55 °C)
 Ex tD A21 IP66 T200 °C
 DEMKO 09 ATEX 0803119X

EMPTY ENCLOSURE

Class II, Division 2
 Class I, Zone 1, AEx e II
 Ex e II (Canada)
 NEMA Type 4
 DEMKO 01 ATEX 0112700U
 CE 0539 II 2 GD
 Ex e II
 Ex tD A21 IP66
 IECEx UL 10.0021U
 Ex e II
 Ex tD A21 IP66



INCREASED SAFETY

TERMINAL ENCLOSURES

INCREASED SAFETY ENCLOSURES

VH4X6 Series

Mounting feet on left and right of enclosure.

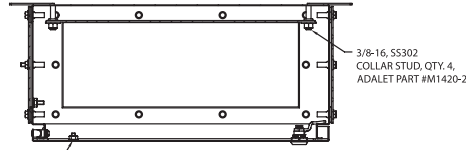

COVER GROUND, 1/4-20x1/2 CDSF STUD ADALET PART #M1420-1

SECTION A-A

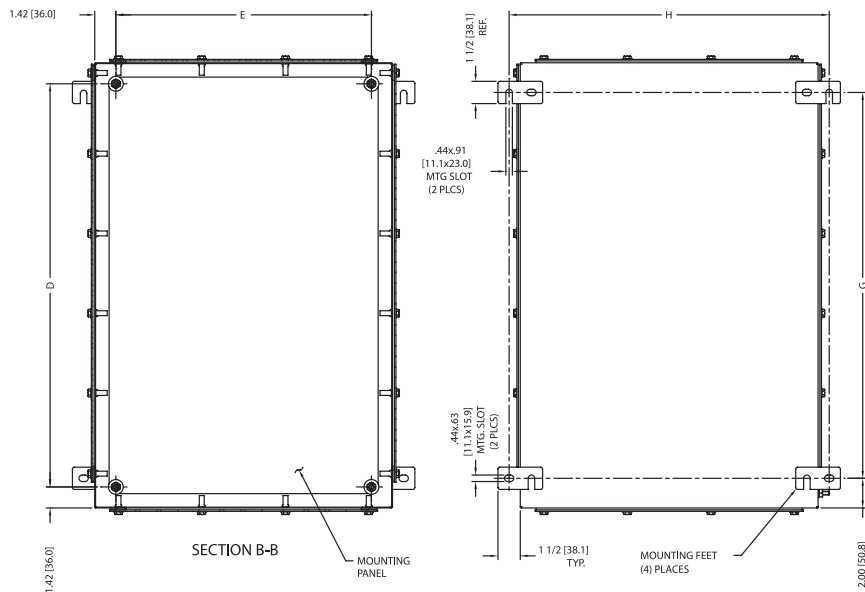
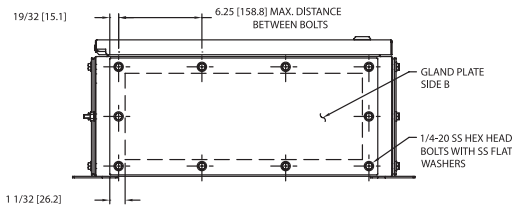
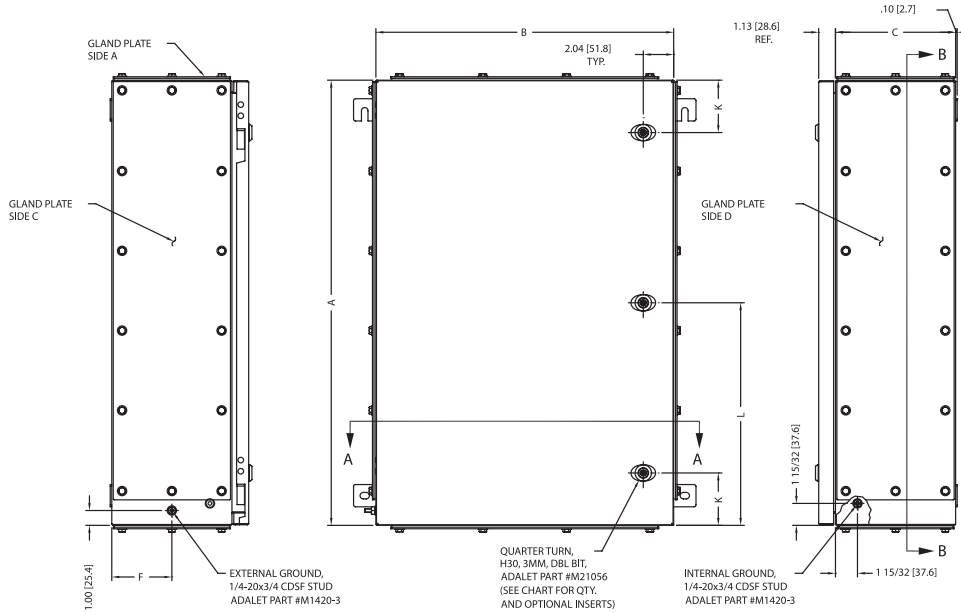

STAINLESS STEEL 316L

INCHES

Catalog Number	Enclosure Dimensions			Collar Stud Spacing		Grd. Stud Locations		Mounting Feet Spacing		# Qtr. Turns	Quarter Turn Locations	
	ENCLOSURE	A	B	C	D	E	F	G	H		L	K
VH4X6-101006	10.24	10.24	6.30	7.40	7.40	3.15	6.24	11.74	1	5.12	-	
VH4X6-101008	10.24	10.24	8.07	7.40	7.40	4.04	6.24	11.74	1	5.12	-	
VH4X6-121206	12.05	12.05	6.30	9.22	9.22	3.15	8.05	13.55	1	6.03	-	
VH4X6-121208	12.05	12.05	8.07	9.22	9.22	4.04	8.05	13.55	1	6.03	-	
VH4X6-151006	14.96	10.24	6.30	12.13	7.40	3.15	10.96	11.74	1	7.48	-	
VH4X6-151008	14.96	10.24	8.07	12.13	7.40	4.04	10.96	11.74	1	7.48	-	
VH4X6-181506	18.03	15.04	6.30	15.20	12.21	3.15	14.03	16.54	1	9.02	-	
VH4X6-191908	18.90	18.90	8.07	16.07	16.07	4.04	14.90	20.40	1	9.45	-	
VH4X6-201406	19.68	13.78	6.30	16.85	10.95	3.15	15.68	15.28	1	9.84	-	
VH4X6-201408	19.68	13.78	8.07	16.85	10.95	4.04	15.68	15.28	1	9.84	-	
VH4X6-241808	24.41	17.72	8.07	21.58	14.89	4.04	20.41	19.22	2	-	3.53	
VH4X6-292208	29.13	21.65	8.07	26.30	18.82	4.04	25.13	23.15	2	-	3.53	
VH4X6-302008	30.00	20.00	8.07	27.17	17.17	4.04	26.00	21.50	2-		3.53	

NOTES Optional Gland Plate Suffixes:

- A: Gland Plate On Top Side
- B: Gland Plate On Bottom Side
- C: Gland Plate On Left Side
- D: Gland Plate On Right Side

**Omit dashes when multiple gland plates are installed.*

INCREASED SAFETY

TERMINAL ENCLOSURES

INCREASED SAFETY ENCLOSURES

VC4X6 Series Vertical Mount

Mounting feet can be on left and right OR top and bottom of enclosure.

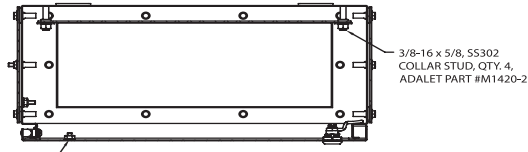

SECTION C-C

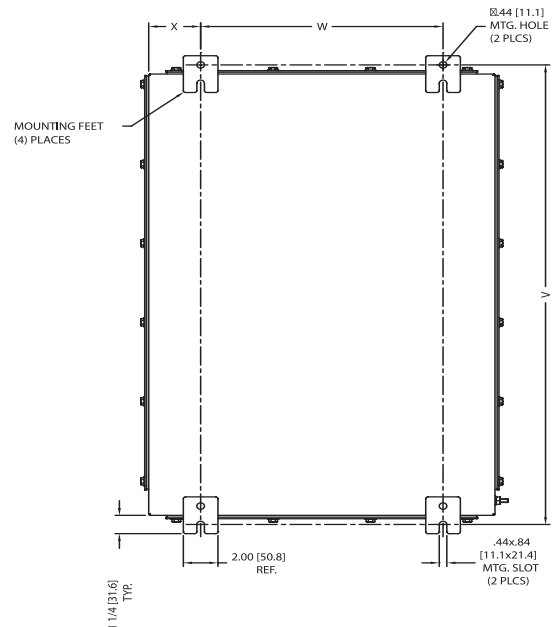
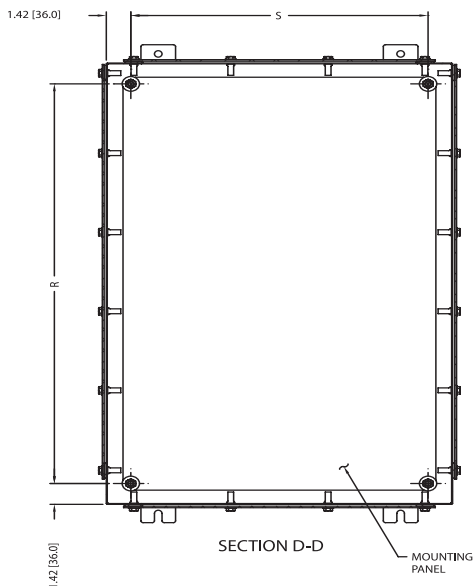
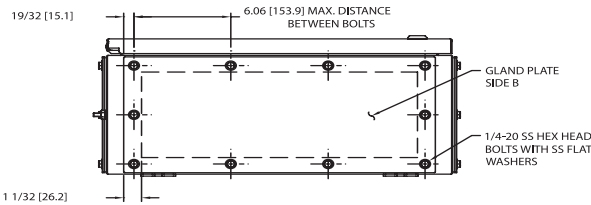
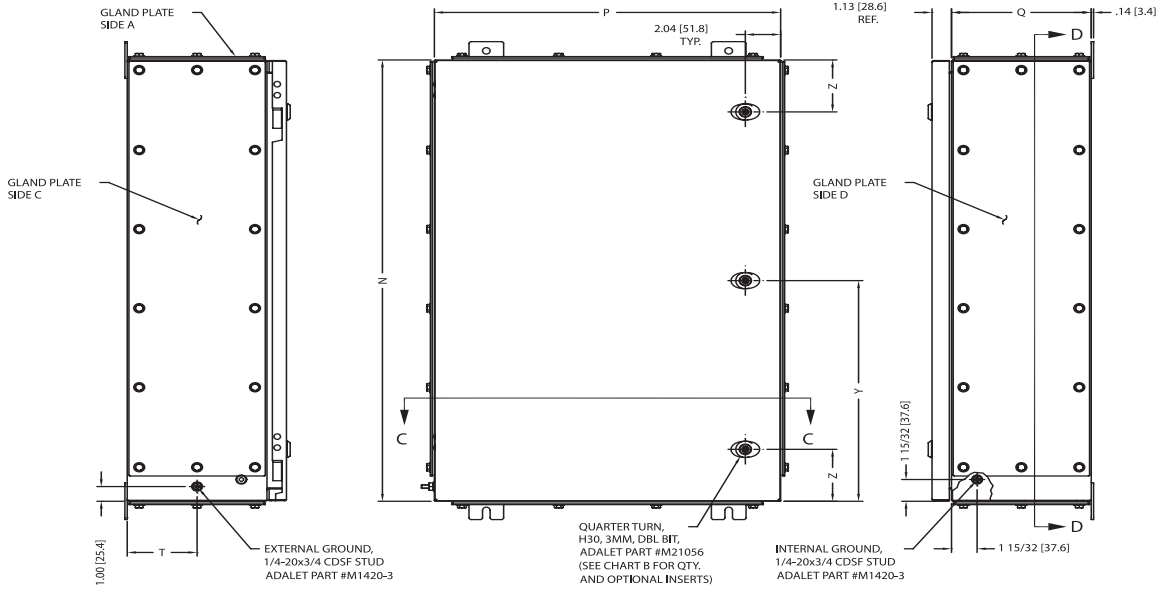

STAINLESS STEEL 316L

INCHES

Catalog Number	Enclosure Dimensions			Collar Stud Spacing		Grd. Stud Locations		Mounting Feet Spacing			# Qtr. Turns	Quarter Turn Locations	
	N	P	Q	R	S	T	V	W	X	Y		Z	
VC4X6-090605V	9.00	6.00	5.00	6.17	3.17	2.50	10.24	3.50	1.25	1	4.50	-	
VC4X6-120806V	12.00	8.00	6.30	9.17	5.17	3.15	13.24	5.50	1.25	1	6.00	-	
VC4X6-121206V	12.05	12.05	6.3	9.22	9.22	3.15	13.24	9.50	1.28	1	6.03	-	
VC4X6-161206V	16.00	12.00	8.00	13.17	9.17	3.15	17.24	9.50	1.25	1	8.00	-	
VC4X6-161208V	16.00	12.00	8.00	13.17	9.17	4.00	17.24	9.50	1.25	1	8.00	-	
VC4X6-161606V	16.00	16.00	6.30	13.17	13.17	3.15	17.24	10.00	3.00	1	8.00	-	
VC4X6-161608V	16.00	16.00	8.00	13.17	13.17	4.00	17.24	10.00	3.00	1	8.00	-	
VC4X6-162006V	16.00	20.00	6.30	13.17	17.17	3.15	17.24	14.00	3.00	1	8.00	-	
VC4X6-162008V	16.00	20.00	8.00	13.17	17.17	4.00	17.24	14.00	3.00	1	10.00	-	
VC4X6-201606V	20.00	16.00	6.30	17.17	13.17	3.15	21.24	10.00	3.00	1	10.00	-	
VC4X6-201608V	20.00	16.00	8.00	17.17	13.17	4.00	21.24	10.00	3.00	1	10.00	-	
VC4X6-202006V	20.00	20.00	6.30	17.17	13.17	3.15	21.24	14.00	3.00	1	10.00	-	
VC4X6-202008V	20.00	20.00	8.00	17.17	17.17	4.00	21.24	14.00	3.00	1	10.00	-	
VC4X6-202408V	20.00	24.00	8.00	17.17	21.17	4.00	21.24	18.00	3.00	1	10.00	-	
VC4X6-241606V	24.00	16.00	6.30	21.17	13.17	3.15	25.24	10.00	3.00	2	-	3.53	
VC4X6-241608V	24.00	16.00	8.00	21.17	13.17	4.00	25.24	10.00	3.00	2	-	3.53	
VC4X6-242006V	24.00	20.00	6.30	21.17	17.17	3.15	25.24	10.00	3.00	2	-	3.53	
VC4X6-242008V	24.00	20.00	8.00	21.17	17.17	4.00	25.24	14.00	3.00	2	-	3.53	
VC4X6-242406V	24.00	24.00	6.30	21.17	21.17	3.15	25.24	18.00	3.00	2	-	3.53	
VC4X6-242408V	24.00	24.00	8.00	21.17	21.17	4.00	25.24	18.00	3.00	2	-	3.53	
VC4X6-243008V	24.00	30.00	8.00	21.17	27.17	4.00	25.24	24.00	3.00	2	-	3.53	
VC4X6-302008V	30.00	20.00	8.07	27.17	17.17	4.04	31.24	14.00	3.00	2	-	3.53	
VC4X6-302408V	30.00	24.00	8.00	27.17	21.17	4.00	31.24	18.00	3.00	2	-	3.53	
VC4X6-303008V	30.00	30.00	8.00	27.17	27.17	4.00	31.24	24.00	3.00	2	-	3.53	

NOTES Optional Gland Plate Suffixes:

- A: Gland Plate On Top Side
- B: Gland Plate On Bottom Side
- C: Gland Plate On Left Side
- D: Gland Plate On Right Side

*Omit dashes when multiple gland plates are installed.

INCREASED SAFETY

TERMINAL ENCLOSURES

INCREASED SAFETY ENCLOSURES

VC4X6 Series Horizontal Mount

Mounting feet can be on left and right OR top and bottom of enclosure.

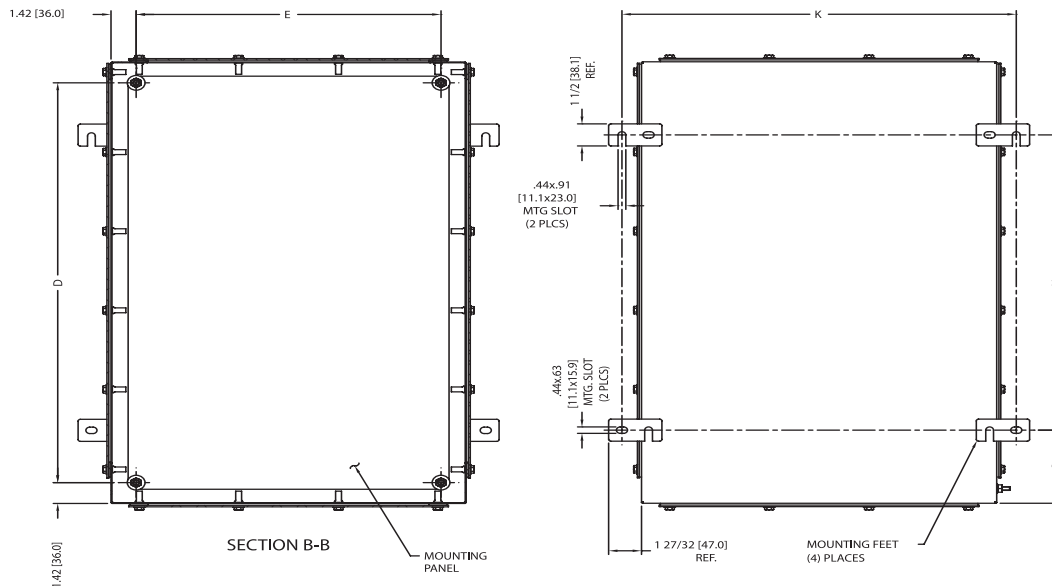
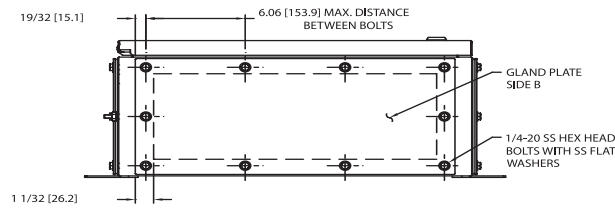
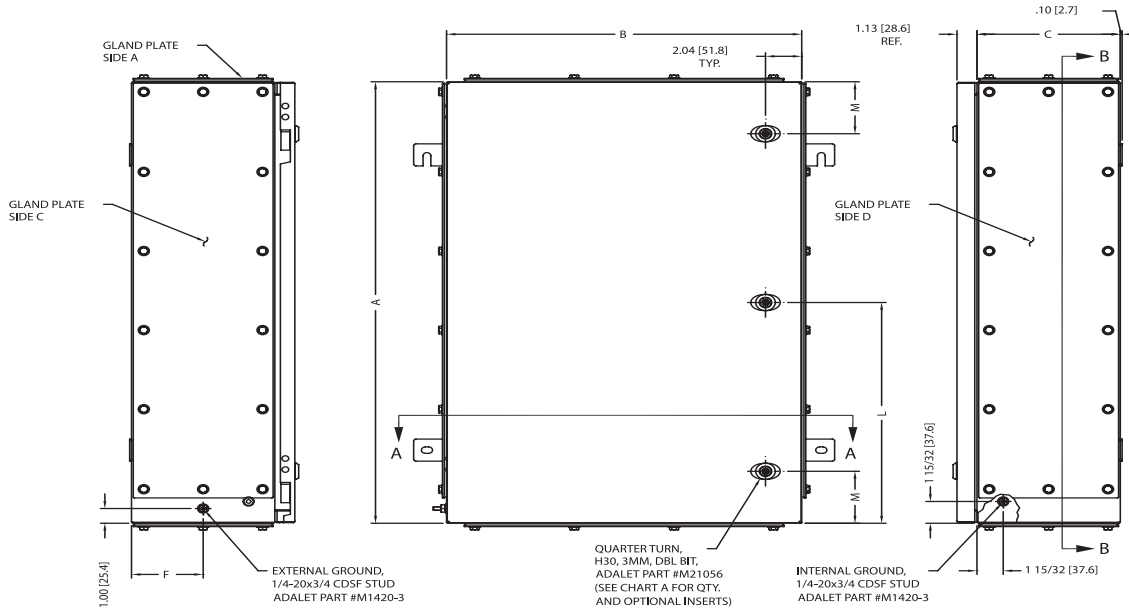
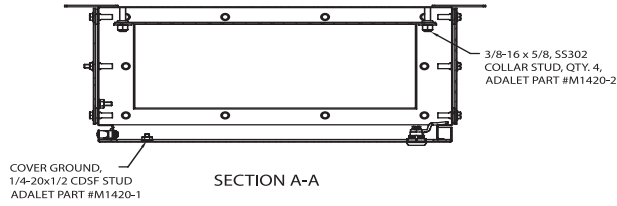

STAINLESS STEEL 316L

INCHES

Catalog Number	Enclosure Dimensions			Collar Stud Spacing		Grd. Stud Locations		Mounting Feet Spacing			# Qtr. Turns	Quarter Turn Locations	
	A	B	C	D	E	F	H	K	G	L		M	
VC4X6-090605H	9.00	6.00	5.00	6.17	3.17	2.50	1.51	5.98	8.19	1	4.50	-	
VC4X6-120806H	12.00	8.00	6.30	9.17	5.17	3.15	2.01	7.99	10.20	1	6.00	-	
VC4X6-121206H	12.05	12.05	6.3	9.22	9.22	3.15	2.03	7.99	14.21	1	6.03	-	
VC4X6-161206H	16.00	12.00	8.00	13.17	9.17	3.15	2.74	10.51	14.21	1	8.00	-	
VC4X6-161208H	16.00	12.00	8.00	13.17	9.17	4.00	2.74	10.51	14.21	1	8.00	-	
VC4X6-161606H	16.00	16.00	6.30	13.17	13.17	3.15	2.74	10.51	18.19	1	8.00	-	
VC4X6-161608H	16.00	16.00	8.00	13.17	13.17	4.00	2.74	10.51	18.19	1	8.00	-	
VC4X6-162006H	16.00	20.00	6.30	13.17	17.17	3.15	2.74	10.51	22.20	1	8.00	-	
VC4X6-162008H	16.00	20.00	8.00	13.17	17.17	4.00	2.74	10.51	22.20	1	10.00	-	
VC4X6-201606H	20.00	16.00	6.30	17.17	13.17	3.15	3.03	13.94	18.19	1	10.00	-	
VC4X6-201608H	20.00	16.00	8.00	17.17	13.17	4.00	3.03	13.94	18.19	1	10.00	-	
VC4X6-202006H	20.00	20.00	6.30	17.17	13.17	3.15	3.03	13.94	22.20	1	10.00	-	
VC4X6-202008H	20.00	20.00	8.00	17.17	17.17	4.00	3.03	13.94	22.20	1	10.00	-	
VC4X6-202408H	20.00	24.00	8.00	17.17	21.17	4.00	3.03	13.94	26.22	1	10.00	-	
VC4X6-241606H	24.00	16.00	6.30	21.17	13.17	3.15	3.24	17.52	18.19	2	-	3.53	
VC4X6-241608H	24.00	16.00	8.00	21.17	13.17	4.00	3.24	17.52	18.19	2	-	3.53	
VC4X6-242006H	24.00	20.00	6.30	21.17	17.17	3.15	3.24	17.52	22.20	2	-	3.53	
VC4X6-242008H	24.00	20.00	6.30	21.17	17.17	4.00	3.24	17.52	22.20	2	-	3.53	
VC4X6-242406H	24.00	24.00	6.30	21.17	21.17	3.15	3.24	17.52	26.22	2	-	3.53	
VC4X6-242408H	24.00	24.00	8.00	21.17	21.17	4.00	3.24	17.52	26.22	2	-	3.53	
VC4X6-243008H	24.00	30.00	8.00	21.17	27.17	4.00	3.24	17.52	32.20	2	-	3.53	
VC4X6-302008H	30.00	20.00	8.07	27.17	17.17	4.04	5.00	20.00	22.20	2	-	3.53	
VC4X6-302408H	30.00	24.00	8.00	27.17	21.17	4.00	5.00	20.00	26.22	2	-	3.53	
VC4X6-303008H	30.00	30.00	8.00	27.17	27.17	4.00	5.00	20.00	32.20	2	-	3.53	

NOTES Optional Gland Plate Suffixes:

- A: Gland Plate On Top Side
- B: Gland Plate On Bottom Side
- C: Gland Plate On Left Side
- D: Gland Plate On Right Side

*Omit dashes when multiple gland plates are installed.